

# 240W PA MIXER-AMPLIFIER 70V/100V

Model: DA240R User Manual

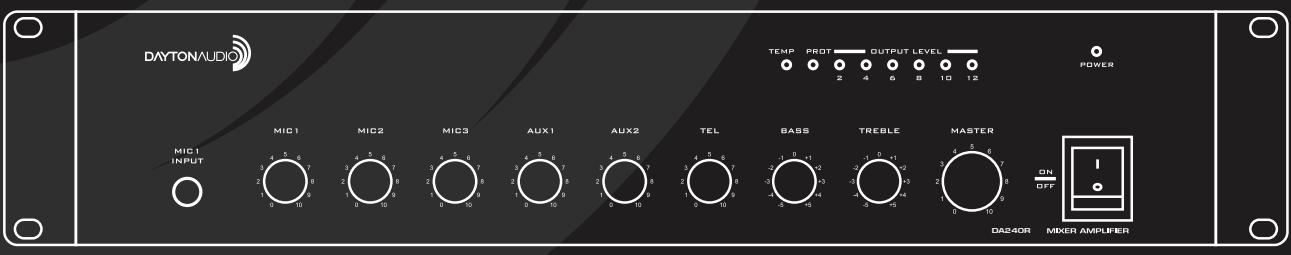

**TABLE OF CONTENTS**

- 1. **SAFETY PRECAUTIONS** ..... 3
- 2. **FEATURES**.....5
- 3. **FEATURES AND FUNCTION**
  - 3.1 Front panel.....6
  - 3.2 Rear panel..... 7
- 4. **CONNECTIONS**
  - 4.1 Speaker Connections.....8
- 5. **OPERATION**.....9
- 6. **APPLICATIONS**.....10
- 7. **APPLICATION DIAGRAM**..... 11
- 8. **SPECIFICATIONS**..... 12
- 9. **DIMENSIONAL DIAGRAM**.....13

# 1. SAFETY PRECAUTIONS

- Be sure to carefully read all the safety instructions in this manual before use.
- Be sure to follow all safety instructions in this manual.
- Please keep this instruction manual for future reference.

## Safety Warning and Cautions

Safety Cautions and Warnings are used in this manual to prevent bodily injury and property damage. Before operating this product please read and follow all safety precautions to avoid potential safety risks.



### WARNING

Indicates a potentially hazardous situation which could result in serious personal injury or death.



### CAUTION

Indicates a potentially hazardous situation which could result in minor or major personal injury or property damage.



### WARNING

#### When Installing the Unit

- Do not expose this product to rain or an environment where it could be splashed by water or other liquids.
- Only use this product with the voltage specified. Using higher voltage may result in fire or electric shock.
- Do not cut, kink, damage or modify the power cord. Avoid using the power cord in close proximity to heaters, and never place heavy objects on the cord. This could result in electric shock or fire.
- Be sure to replace the speaker terminal cover after the speaker connections are complete. High voltage is applied to the speaker terminals. To avoid electric shock never touch these terminals.
- Be sure you ground the amplifier using the safety ground (earth) terminal to avoid electric shock. Never ground this product to a gas pipe or other flammable items.
- Avoid installing or mounting this product on an unstable or slanted surface. Doing so may cause the unit to fall, resulting in personal injury or property damage.

#### When the Unit is in Use

- Should any of the following issues occur during use, immediately switch off the power and disconnect the power cord from the AC outlet. Make no further attempt to operate the malfunctioning product, doing so may cause fire or electric shock. Contact your Dayton Audio dealer for service and repair.
  1. If you detect smoke or a strange smell coming from the unit.
  2. If any liquid or metal gets inside the product.
  3. If the product is dropped or falls and case is broken.
  4. If the power cord is cut or damaged.
  5. If the sound becomes distorted.
- To prevent a fire or electric shock, never open or remove the product cover; there are high voltage components inside. Refer all servicing and repair to your nearest Dayton Audio dealer.
- Do not place cups, bowls, or anything containing liquid or metal objects on top of the product.
- To prevent fire or electric shock, do not insert metal objects or flammable materials in the cover or vents of this product.

## SAFETY PRECAUTIONS

### CAUTION

- Never plug in or remove the power cord with wet hands, doing so may cause electric shock.
- When unplugging the power cord, be sure to grasp the power cord plug; never pull on the cord itself. Operating the unit with a damaged power cord may cause a fire or electric shock.
- When moving the unit, be sure to remove the power cord from the wall outlet. Moving the unit with the power cord connected to the outlet may cause damage to the power cord or cause you to accidentally drop the product, resulting in personal or property damage.
- Do not block the ventilation areas in the cover. Doing so may cause heat to build up inside the product, resulting in product failure and possibly fire.
- Avoid installing the unit in humid or dusty locations, direct sunlight, near heaters or in locations generating sooty smoke/steam.
- Do not place heavy objects on top of the product. This can result in the product or object to fall, causing personal injury or property damage.
- Before powering on the product make sure that the master volume control is set to the lowest setting. Loud or high volume noise can damage or impair hearing.
- Do not operate the unit if the sound is distorting. This is an indication of a product malfunction, immediately unplug the power and contact your Dayton Audio dealer for service or repair.
- Dust allowed to accumulate inside the product this could result in fire or electrical damage. Be sure to consult your Dayton Audio dealer for cleaning service and repair. Periodically clean dust buildup from the power cord plug and wall outlet to avoid electrical fire. Ensure the power cord plug is securely inserted in the wall outlet.
- For safety when cleaning or leaving the unit unattended for long periods of time, switch the power off, unplug the power cord plug from the wall outlet. Doing otherwise may cause a fire or electric shock.

An all-pole mains switch with a contact separation of at least 3 mm in each pole shall be incorporated in the electrical installation of the building.

## 2. FEATURES

1. Rated Power: 240W.
2. 100V,70V constant voltage outputs and 4~16 ohms constant resistance output.
3. Commercial-grade toroidal transformers produce high performance audio on a wide range of frequencies with minimum noise and high fidelity, even at high volume.
4. Protection against overload, short circuit, and power fluctuation for optimum reliability.
5. VOX feature mutes AUX inputs when input is detected on MIC 1. Time Adjust control allows resumption of music to be sharp or gradual.
6. Phantom power available on MIC 1 input for condenser-type microphones.
7. TEL priority: TEL override AUX1-2 and MIC(2-3).

## 3. FEATURES AND FUNCTIONS

### 3.1 FRONT PANEL

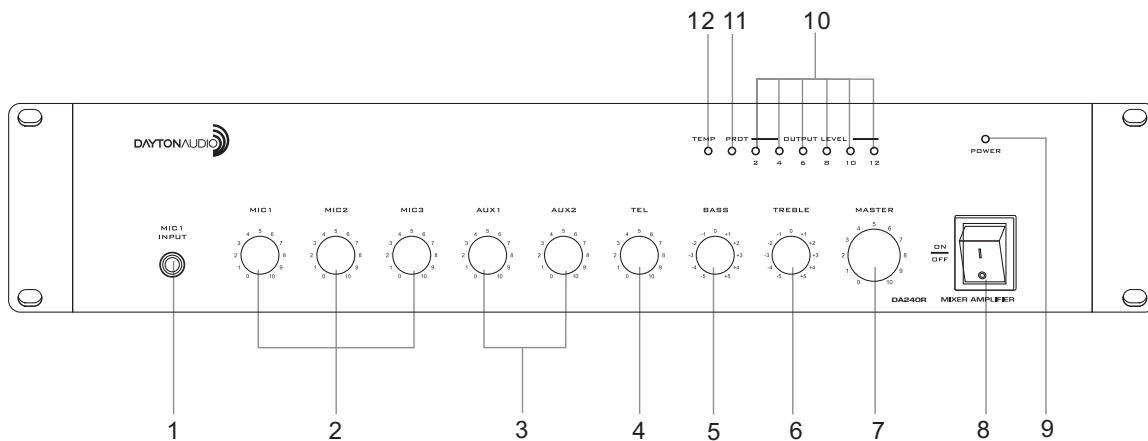

#### 1. MIC1 INPUT

MIC1 1/4" phone jack input

#### 2. MIC1/MIC2/MIC3

MIC volume control (MIC1/MIC2/MIC3)

#### 3. AUX1/AUX2

AUX volume control(AUX1/AUX2)

#### 4. TEL

TEL volume control

#### 5. BASS

Bass response adjustment. Rotate clockwise to increase bass output and counterclockwise to reduce it.

#### 6. TREBLE

Treble response adjustment. Rotate clockwise to increase treble output and counterclockwise to reduce it.

#### 7. MASTER

Master volume control

#### 8. POWER SWITCH

ON/OFF toggle switch

#### 9. POWER

Power indicator

#### 10. LEVEL INDICATORS

Signal output level indicators

#### 11. PROT

Protection mode status indicator.

This indicator will illuminate if the product is in protection mode due to overheating or overload.

#### 12. TEMP

High temperature status indicator.

Indicator will be illuminated if the temperature inside the unit becomes too high for normal operation.

## FEATURES AND FUNCTIONS

### 3.2 REAR PANEL

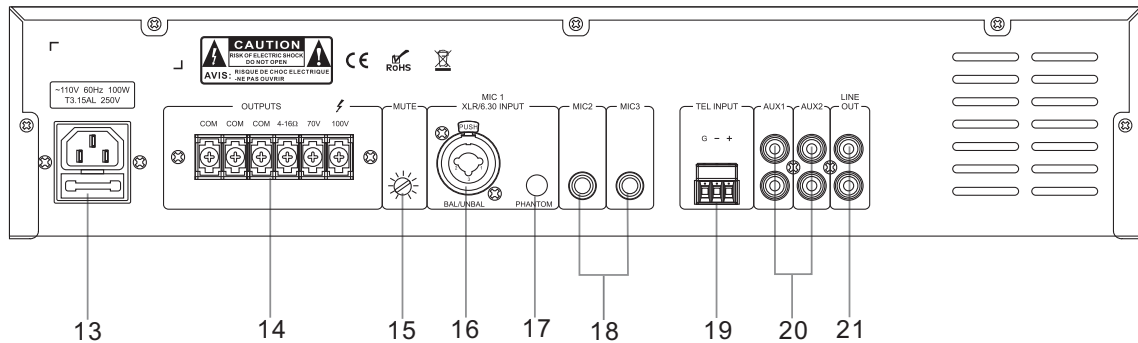

13. ~110V 60Hz POWER INPUT

14. SPEAKER TERMINALS

Connectors for 4-16 ohms or 70V and 100V speaker

15. Mute adjustment

Adjusts the mute level from 0-20 dB during signal override of all channels by MIC1 input.

16. MIC1 input compatible with XLR and 1/4" phono plugs

17. Phantom power ON/OFF switch

18. (MIC2/ MIC3) MIC input

MIC 2-3 inputs 1/4" Phono plug

19. TEL INPUT

Ground, Negative, Positive

20. (AUX1/AUX2) AUX input

AUX 1-2 inputs

Auxiliary inputs for additional audio equipment.

21. LINE OUT

L/R RCA outputs for sending audio to additional equipment

## 4. CONNECTIONS

### 4.1 SPEAKER CONNECTIONS

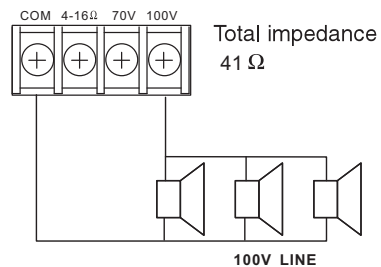
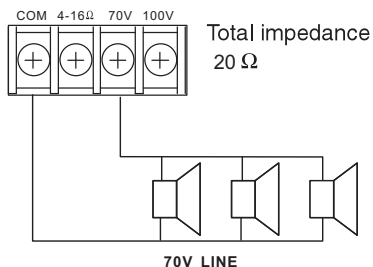
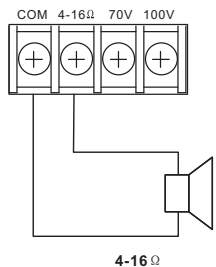

#### Notes

- The 4-16 ohm and 70V/100V terminals cannot both be used at the same time.
- Impedances indicated in the figures represent the total speaker system (load) impedances.

## WARNING

Be sure to replace the speaker terminal cover after speaker connections have been made.

### 4.2 XLR CONNECTIONS

Combined XLR (female)/phone jack connectors.

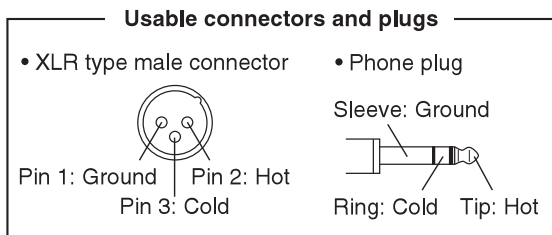



## 5. OPERATION

### OPERATION

You can choose only two of the four output connectors to work together. If voltage is 70V/100V the speakers must have a transformer, make sure the total power wattage of speaker is 15% less than the power wattage of amplifier.

### MUTE FUNCTION

1. TEL has priority over all inputs.
2. MIC 1 is second priority, adjusting the mute level can override all other input signals except for the TEL signal.

### TROUBLESHOOTING

Problems	Cause
All wires are connected properly but there is no audio output.	1.No power or wrong connection 2.Fuse is blown 3.Volume is turned off 4.No input signal
Alarm sounds when power is turned on	1.Overloading or short circuit 2.Voltage is not stable, too high or low
No output	1.Product is in protection mode due to high temperature or malfunction. 2.Wrong wiring or connections

# 6. APPLICATIONS

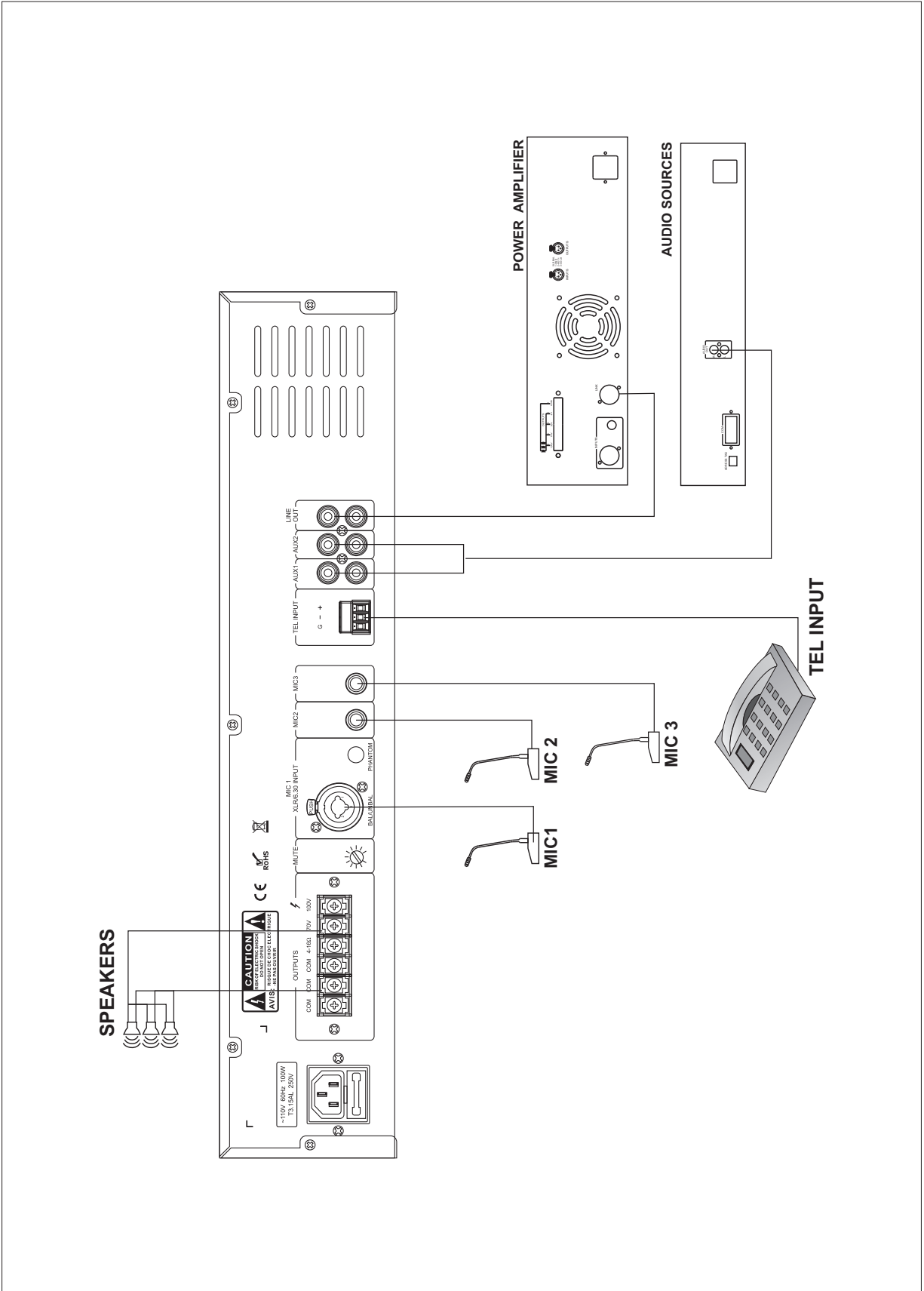

# 7. APPLICATIONS DIAGRAM

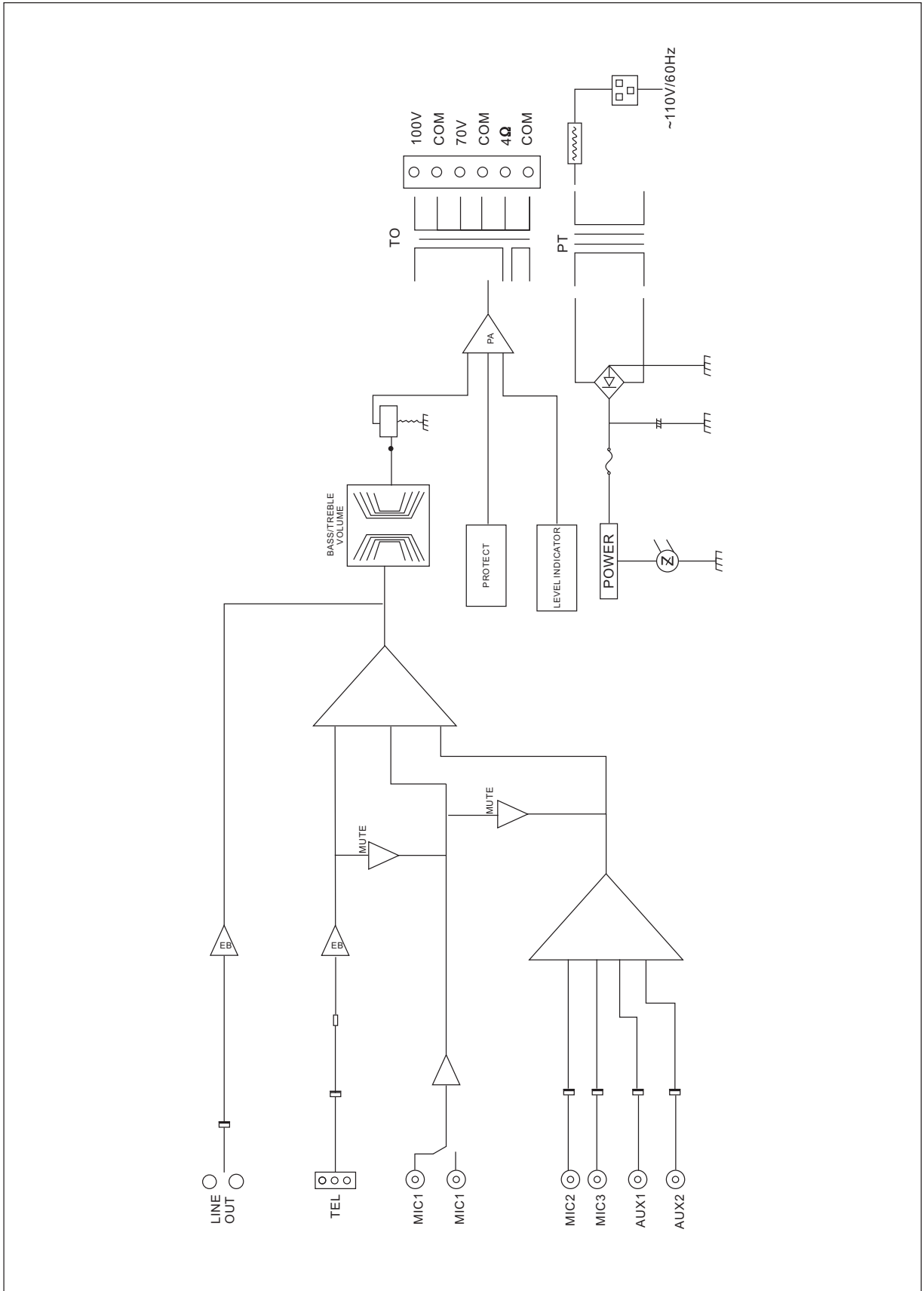

## 8. SPECIFICATIONS

MIXER AMPLIFIER	
Model	DA240R
Rated power output	240W
Speaker line input	4~16Ω, 70V, 100V
Input sensitivity/impedance	MIC1,2,3: 5mV/600 ohms AUX: 350mV/10,000 ohms
S/N	Better than 90 dB
Frequency response (At 1 kHz half power output,+3 dB)	50-18,000 Hz
Total harmonic distortion	Less than 0.3%
Line level output	~10 dB/3,000 ohms
Cooling mode	Air cooling
Power source	~110V, 60Hz
Power consumption	400W
Net weight	25.4 lbs.
Dimensions	19" W x 14" D x 3.466" H
MIC 1~2 input section (CH1~2 in @ 1 kHz, preamp out)	
Input sensitivity/impedance	5mV/600 ohms
S/N	Better than 62 dB
Tone control (Bass:100 Hz, Treble: 10 kHz)	+10 dB
Phantom power	+48 VDC
AUX 1 input section (AUX in @ 1kHz, preamp out)	
Input sensitivity/impedance	350mV/10,000 ohms
S/N	Better than 76 dB
Frequency response (+3 dB)	50-18,000 Hz
Tone control (Bass: 100 Hz, Treble: 10 kHz)	+12 dB
Pre amp out	5 dBV/600 ohms

## 9. DIMENSIONAL DIAGRAM

UNIT:mm

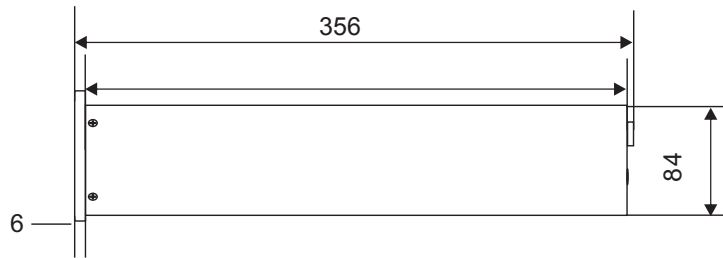
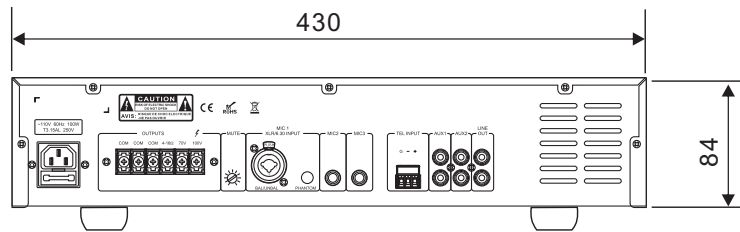
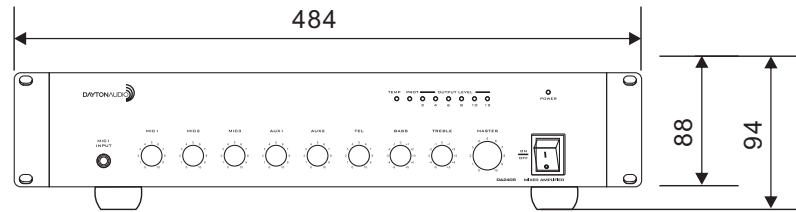

Keeps all sides of the product clear and free of objects that may obstruct the air flow and prevent proper cooling of the product.

UNIT:mm

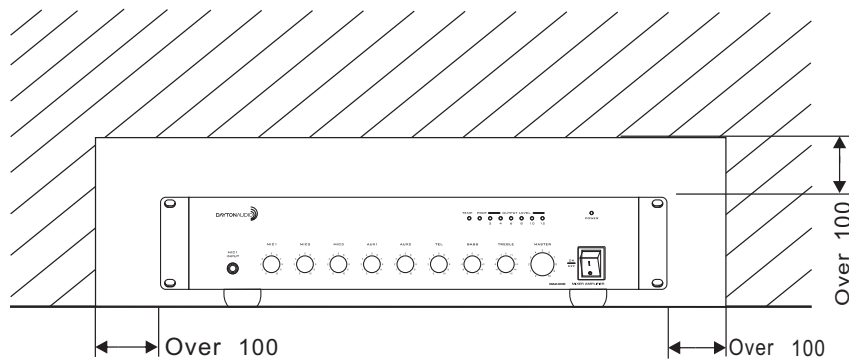

**5-Year Limited Warranty**  
See [daytonaudio.com](http://daytonaudio.com) for details



**daytonaudio.com**  
tel + 937.743.8248  
[info@daytonaudio.com](mailto:info@daytonaudio.com)

705 Pleasant Valley Dr.  
Springboro, OH 45066  
USA

