

Features

- 8" Kevlar impregnated paper cone
- 4-layer 4 ohm voice coil
- Rubber surround
- Vented pole piece
- High excursion
- High power handling
- Works great in small sealed enclosures
- Made in the USA

Parameters

Impedance (Ω)	4
Re (Ω)	3.9
Le (mH) @ 1 kHz	2.18
Fs (Hz)	42.4
Qms	11.22
Qes	0.50
Qts	0.48
Mms (g)	39.54
Cms (mm/N)	0.36
Sd (cm ²)	213.8
Vd (liters)	203.1
BL (Tm)	9.19
VAS (liters)	22.9
XMAX (mm)	9.5
VC Diameter (mm)	38
SPL (dB@1W/1m)	86.2
RMS Power Handling (w)	150
Usable Frequency Range (Hz)	35 - 200

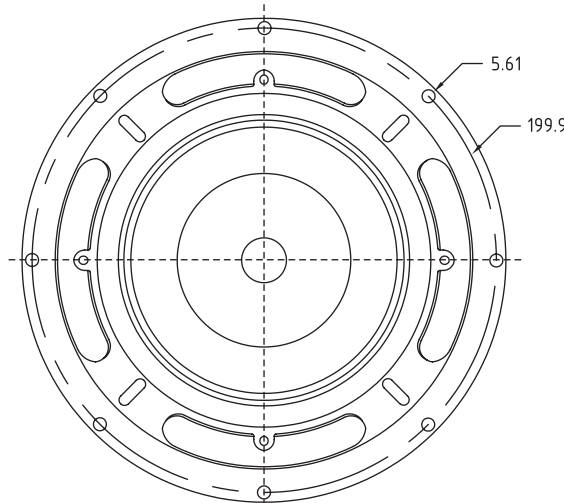
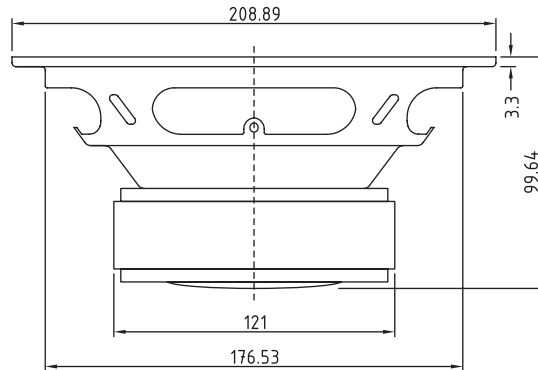

Note: All dimensions in mm.

Frequency Response

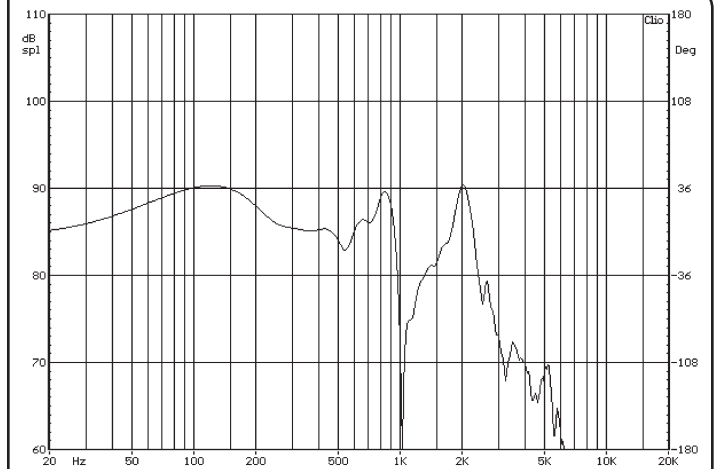

Note: Due to testing limitations, response below 200 Hz is not an actual representation.

Impedance/Phase

