

QT255-4**10" Quatro Subwoofer 4 Ohm****QT255-4****10" Quatro Subwoofer 4 Ohm****Features**

- 10" Kevlar impregnated paper cone
- 4-layer 4 ohm voice coil
- Rubber surround
- Vented pole piece
- High excursion
- High power handling
- Works great in small sealed enclosures
- Made in the USA

Parameters

Impedance (Ω)	4
Re (Ω)	3.4
Le (mH) @ 1 kHz	1.82
Fs (Hz)	29.6
Qms	9.92
Qes	0.29
Qts	0.29
Mms (g)	81.33
Cms (mm/N)	0.36
Sd (cm ²)	346.4
Vd (liters)	275.0
BL (Tm)	13.55
VAS (liters)	59.9
XMAX (mm)	7.94
VC Diameter (mm)	51
SPL (dB@1W/1m)	89.3
RMS Power Handling (w)	200
Usable Frequency Range (Hz)	30 - 200

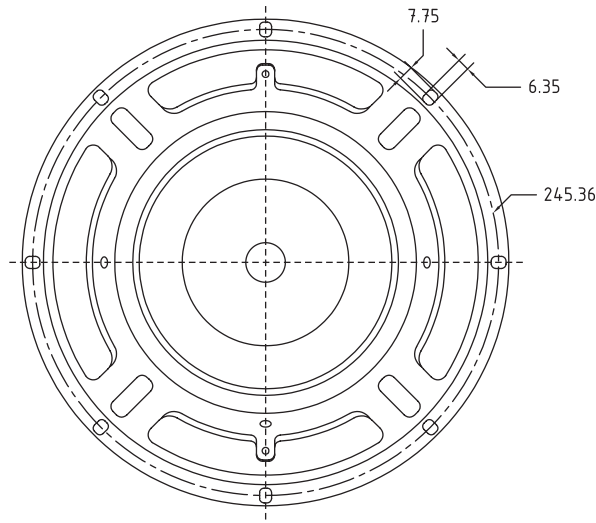
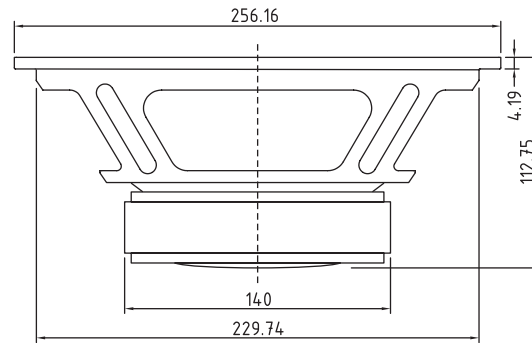

Note: All dimensions in mm.

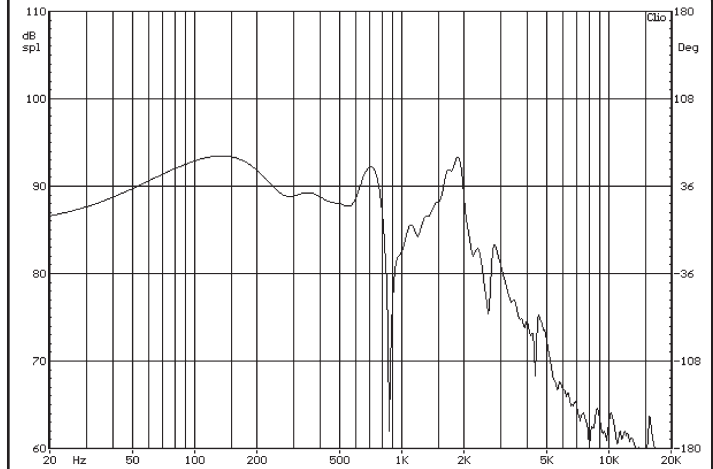
Frequency Response

Note: Due to testing limitations, response below 200 Hz is not an actual representation.

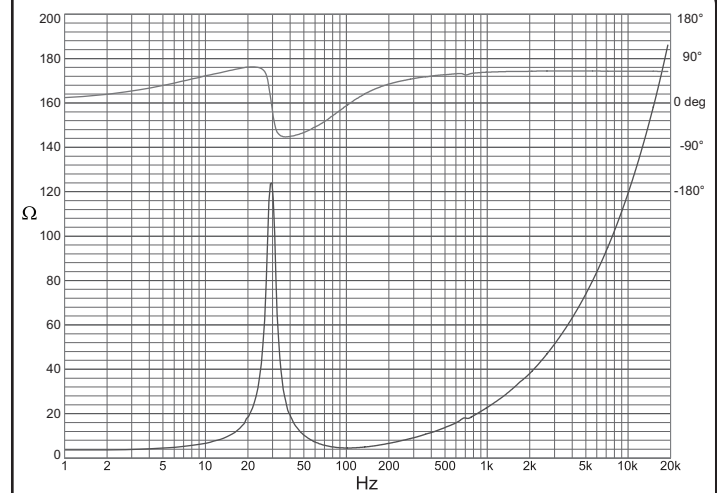
Impedance/Phase

daytonaudio.com

© Dayton Audio