

SD270-88**10" Shielded DVC Subwoofer****SD270-88****10" Shielded DVC Subwoofer****Features**

- 10" heavy duty paper cone
- Magnetically shielded
- Durable rubber surround
- Dual 8 ohm voice coils
- High power motor structure
- Long-throw design
- Well suited for both sealed and vented designs

Parameters

Impedance (Ω)	4
Re (Ω)	3.1
Le (mH) @ 1 kHz	1.11
Fs (Hz)	29.6
Qms	3.20
Qes	0.51
Qts	0.44
Mms (g)	46.78
Cms (mm/N)	0.62
Sd (cm ²)	359.7
Vd (liters)	215.8
BL (Tm)	7.27
VAS (liters)	112.2
XMAX (mm)	6
VC Diameter (mm)	38
SPL (dB@1W/1m)	89.7
RMS Power Handling (w)	80
Usable Frequency Range (Hz)	30 - 1500

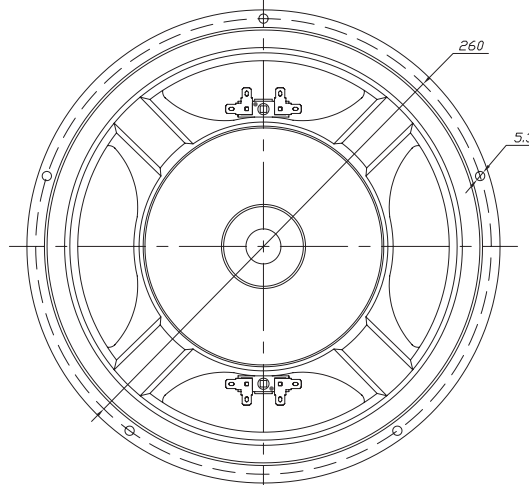
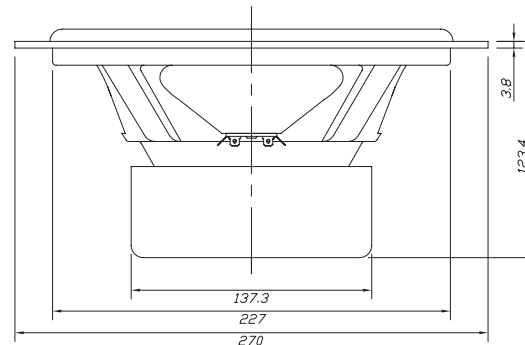

Note: All dimensions in mm.

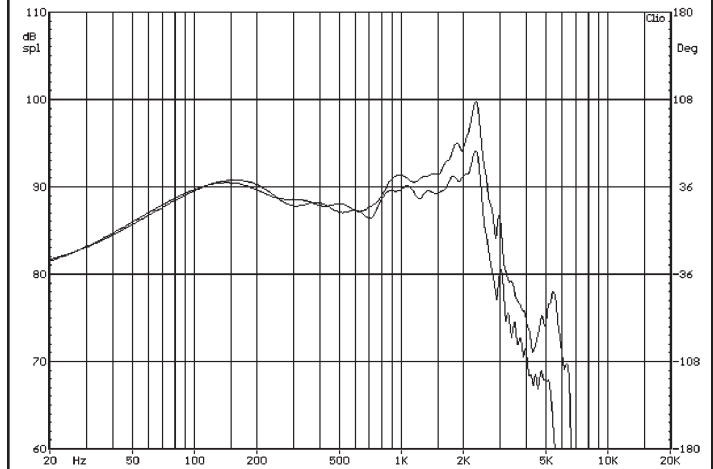
Frequency Response

Note: Due to testing limitations, response below 200 Hz is not an actual representation.

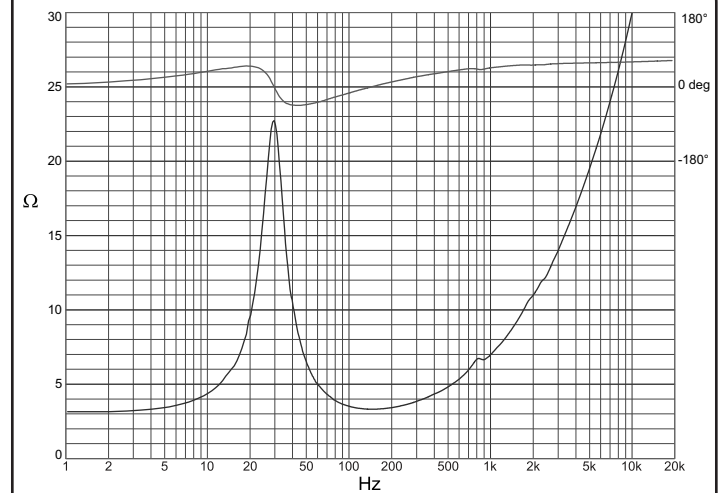
Impedance/Phase

daytonaudio.com

© Dayton Audio