

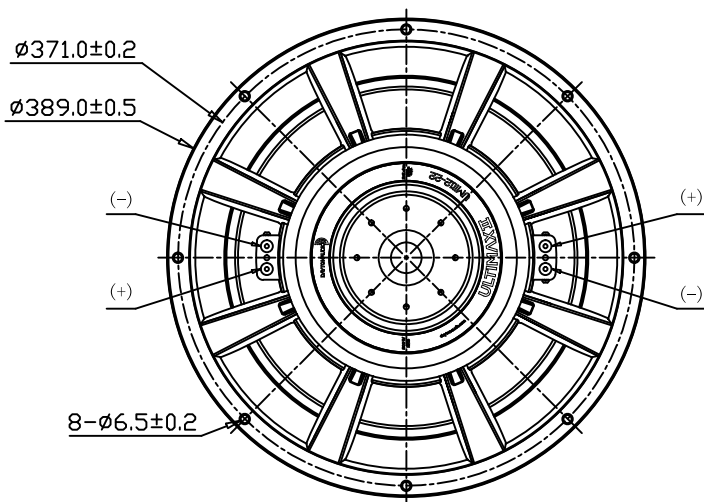

Ultimax II 15" DVC Subwoofer 2 Ohm Per Coil

UMII15-22

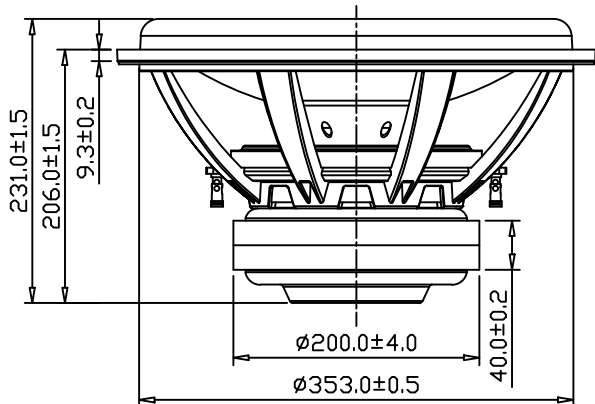

PARAMETERS

Impedance	2 + 2 ohms *
Re	4.2 ohms
Le @ 1 kHz	0.70 mH
Fs	29 Hz
Qms	2.34
Qes	1.00
Qts	0.70
Mms	279g
Cms	0.110 mm/N
Sd	791 cm ²
Vd	1897 cm ³
BL	14.6 Tm
Vas	96 liters
Xmax	24 mm **
VC Diameter	76 mm
SPL	88.5 dB@2.83V/1m
RMS Power Handling (AES 426B)	900 watts
Usable Frequency Range (Hz)	20 - 300 Hz

*Dual 2-ohm voice coils. All specifications measured with voice coils wired in series.
**at 70% BI (Klippel verified)

IMPEDANCE/PHASE

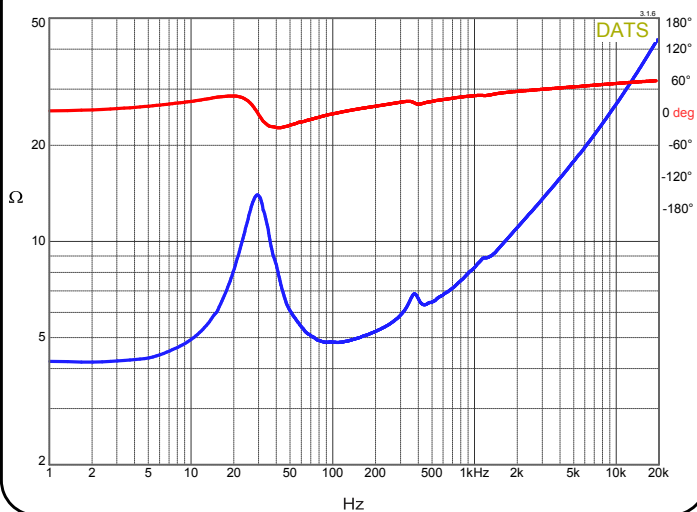

FEATURES

- 24 mm Xmax allows the driver to displace substantial amounts of air
- 3" Flat-wound 4-layer copper voice coil for high power handling
- Woven carbon fiber cone offers a sleek appearance and high rigidity
- Large aluminum pole cap and sleeve to minimize distortion
- Dual spiders maintain cone linearity even at extremely high excursion
- Ample venting facilitates maximum airflow across the voice coil

FREQUENCY RESPONSE

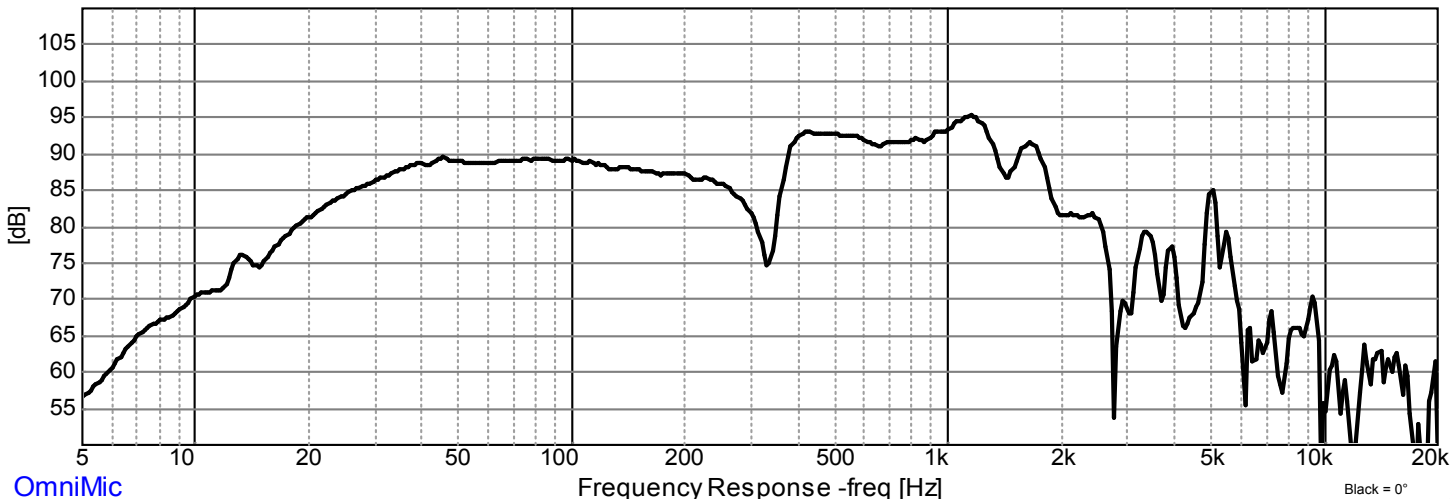

OmniMic

Black = 0°